



Pioneering Change:

**How eTrailer is Shaping the Next Generation of Transport**



---

## Agenda:

- Introduction
- A brief history and mission of Trailer Dynamics
- The eTrailer concept
- Background and Experience in the field
- Extraordinary field test Results:
  - Reduction in Diesel Consumption
  - Extended Range with electric semi trucks
  - Performance Boost

# 01

## Introduction

Project scope and goals



## eTrailer

---

E-vehicles have rapidly established themselves in the global automotive market and form an important pillar in the drive for more environmentally friendly transport solutions. One exciting concept in this area is the eTrailer. eTrailers are trailers that have their own electric drive train. This not only offers the opportunity to increase the performance of the semi truck-trailer application by extending their range or pulling additional loads, but also to improve the dynamics and safety of the semi truck-trailer application.



# 02

## Development history

A brief history and mission of Trailer Dynamics



# Motivation

The founding of Trailer Dynamics was driven by the pressing need to reduce the environmental impact of the transportation sector while increasing efficiency and profitability for our customers. The founders recognized that there was a significant need for innovative solutions to meet the growing environmental and economic challenges facing the industry.

The shareholders' goals are diverse, but at their core are the development and commercialization of forward-looking technologies that reduce CO2 emissions, save fuel and ultimately contribute to a more sustainable transportation industry. The focus is on providing practical and economically viable solutions for fleet operators and transportation companies.

During its growth phase, Trailer Dynamics has been able to attract various companies and investors who believe in the potential of our technology and share the vision of a greener future for the transportation industry. The companies and investors involved include strategic partners from the automotive and logistics industries, as well as institutional investors and venture capitalists looking to invest in green technologies.

These partnerships enable us to further develop our product, accelerate market access and put our mission into practice.



Michael Nimtsch  
Managing Director - CFO

Abdullah Jaber  
Technical Leadership – CEO

Jochen Mählmann  
Managing Director - COO

## Company Founding (2018):

The innovative vision that sparked the company's formation.

This vision was centered on enhancing the efficiency of diesel tractor units over long hauls and, crucially, on addressing the range limitations of electric tractor units. The innovative solution proposed by Trailer Dynamics was to integrate part of the drivetrain into the trailer—leveraging unused payload capacity and available space to support electric propulsion.

## Core Idea and Innovation:

The basic idea that set Trailer Dynamics apart was shifting components of the drivetrain to the trailer! Trailer Dynamics aimed to not only improve the range of electric tractor units but also to optimize the overall energy efficiency and functionality of freight transportation. This approach represents a significant step forward in sustainable logistics.

### Real Time Control and Predictive Drivetrain Control

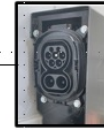
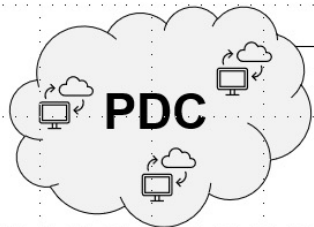

### On-Board Charger

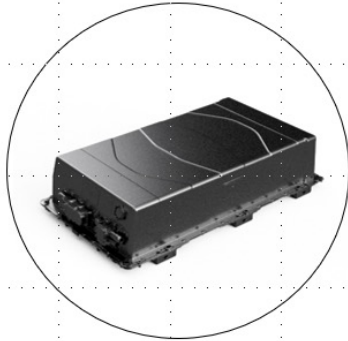
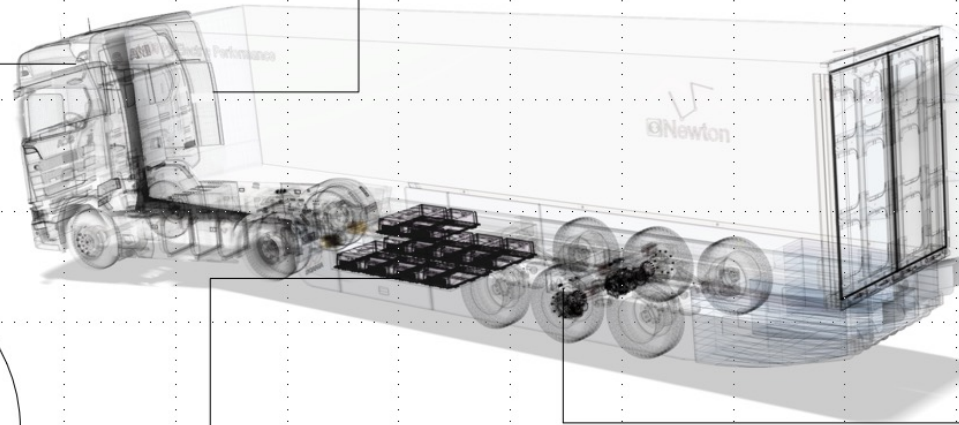

### Battery System

- Lithium-Iron-Phosphat
- Robust and longer service life

### Electric Axle

- High performance
- Propulsion and Recuperation

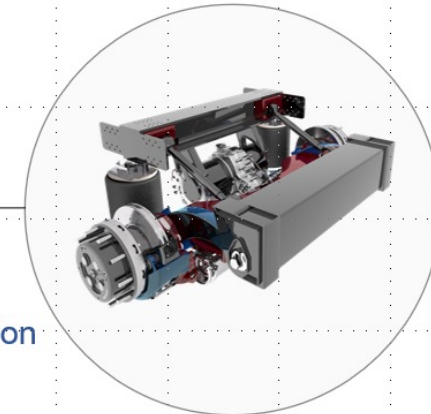





### **Initial Development and Concept Work:**

The basis and foundation of Trailer Dynamics was laid in my early work. The digital twin and the strategic concepts were of great value here. Building on this, the design and maturation of the ideas in the Logistics industry environment were further developed. This period involved extensive research and design work, as the team at Trailer Dynamics worked to turn their pioneering idea into a tangible product.

### **Partnership with PEM Aachen:**

Transition into the strategic partnership with PEM Aachen, spearheaded by Prof. Achim Kampker, a prominent figure in the realm of e-mobility with a successful track record, particularly highlighted by the founding of StreetScooter approximately a decade ago. The collaboration with PEM, renowned for its expertise in the electrification of road logistics, provided Trailer Dynamics with a significant boost in expertise and credibility in the industry.



## Strategic partnership with Krone Trailer:

In 2020, we recorded another milestone. Krone Trailer, a renowned name in the industry, joined Trailer Dynamics as a strategic shareholder. This collaboration opened further doors and opportunities for us.

# Efficiency in the 6th generation



## 1999 Safe Liner

Safer, more economical, quieter. The innovative Safe Liner sets new standards for the transport industry.

## 2004 Euro Combi (Lang LKW)

Der Euro Combi setzt neue Akzente in der Diskussion über den kraftstoffeffizienten Güterfernverkehr.

## 2008 Profi Liner ECO

With the innovative Profi Liner ECO, KRONE has developed an aerodynamic trailer that reduces fuel consumption and thus CO2 emissions in an exemplary manner.

## 2012 Aero Liner-Projektstudie

With the Aero Liner project study, KRONE is consistently pursuing the topic of energy-efficient trailers.

## 2013 E<sup>3</sup> Trail

Die Konzeptstudie eines mit Rekuperationseinheit ausgestatteten Cool Liners steigert die Energieeffizienz des Gesamtsystems.

## 2018 eTrailer

Mit dem Kooperationspartner Trailer Dynamics entwickelt KRONE den ersten eTrailer und setzt dadurch neue Maßstäbe zur Reduzierung des Kraftstoffverbrauchs und CO<sub>2</sub> –Ausstoßes

03

## Technology

The eTrailer concept



# eDryLiner Typ: SDK 27 eLB4.1-STG – D600 - Standard

TECHNISCHE DATEN			
TD D600			
Grundfahrzeug SDK 27 eLB4.1-STG			
Elektrische Funktionalität	Antriebsunterstützung & Rekuperation	On Board Charger	44 kW
Antriebstopologie	2 Synchronmotoren - Zentralstirnradgetriebe	DC Ladeleistung	150 kW
Batteriekapazität	551 kWh nominal	Sattellast	12.000 kg
Nutzbare Batteriekapazität	440 kWh	Achslast technisch möglich	27.000 kg
eMotoren kontinuierliche Leistung	360 kW	zul. Gesamtgewicht (technisch möglich)	39.000 kg
eMotoren maximal Leistung	580 kW	Leergewicht	13.757 kg
eAchse kontinuierliches Drehmoment	7.000 Nm	Nutzlast technisch möglich	25.442 kg
eAchse maximales Drehmoment	11.500 Nm	Nutzlast BRD plus eTrailer Bonus	21.363 kg*
Spannungs-Niveau	472.5 V ~ 689.85 V	Radstand	1.310 mm
Hochvoltsystem	800 Volt	Bauhöhe vorne	100 mm
LV System	12 - 28 V	Sattelhöhe unbeladen	1.150 mm
Datenschnittstelle zu SZM	ISO11992 - 15 poliger Stecker	Länge i. L.	13.620 mm
Hochvoltsystem	800 Volt	Breite i. L.	2.480 mm
Dieserverbrauchsreduktion SZM	20% - 40%	Innenhöhe i. L.	2.715 mm
Aktionsradiuserweiterung BEV SZM	400 km**	Durchladehöhe am Heckportal	2.650 mm
* 2t zulässiges Mehrgewicht für ZEV eTrailer berücksichtigt			
** in Abhängigkeit von Nutzlast, Strecke und Topographie			

# eDryLiner Typ: SDK 27 eLB4.1-STG – D400/D600 - Standard

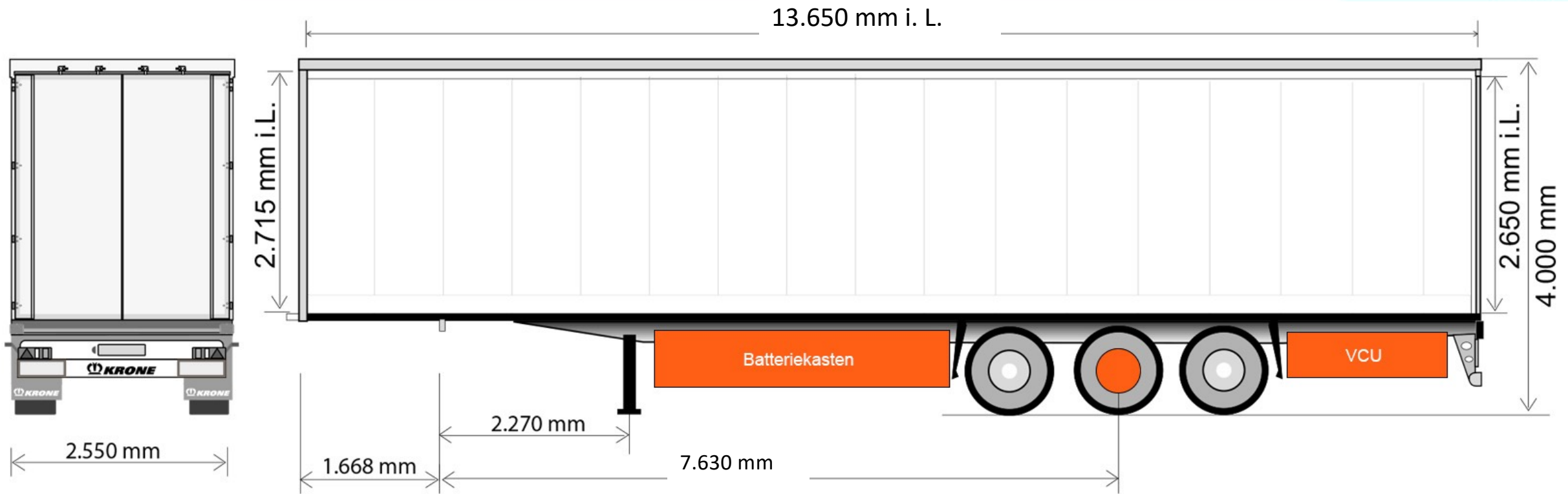

04

## Field Test

Diesel and eTruck tests







Neuigkeiten

Nachhaltigkeit ESG

Partnerschaften

# eTrailer im Test bei DB Schenker: Signifikant weniger Spritverbrauch

DB Schenker in Frankreich und Trailer Dynamics testen eTrailer von Trailer Dynamics im Live-Betrieb

- Dieserverbrauch 24 bis 55 Prozent geringer
- Präzise Prognose des Energiebedarfs

06.04.2023





ELECTRIC

electric

TRAILER DYNAMICS

MISSION RECORD RUN

KRONE

1

POWERED BY KRONE

DIGITALIZATION AUTOMATION SUSTAINABILITY ELECTRIFICATION

AC TD 508E

MISSION RECORD RUN KRONE



Copyright ©: BMW



## BMW-Logistik: 600 km mit Elektro-Lkw dank E-Trailer möglich

# Reichweitenvergleich eActros ohne eTrailer und mit eTrailer

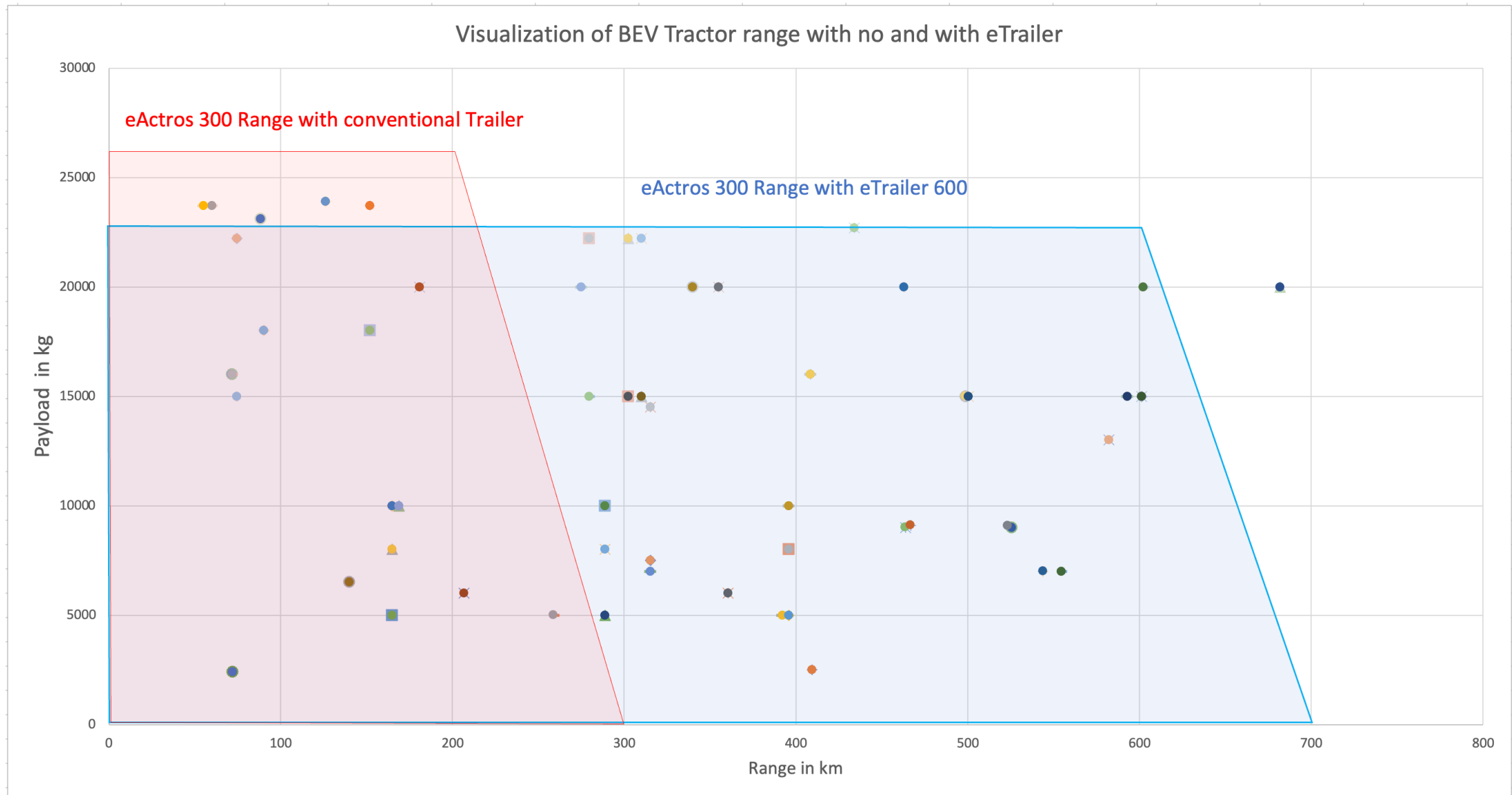



Thank you!

---